

# FCN-224J/225J/228J\*\*\*-G/\*, -G/\*\*

## FCN-220 Series Card-Edge Connectors

### 1.27 mm PITCH CARD-EDGE CONNECTORS

#### FEATURES

- 1.27 mm (0.050 in.) contact pitch
- 30 to 120 pins are available (S-type is 112, 132, 182)
- Double-side connection for 1.6 mm (0.063 in.) thick PCB
- 4 rows staggered 1.27 x 1.905 mm (0.050 x 0.075 in.) terminal pitch
- Insulation is UL recognized, and is cleanable

#### SPECIFICATIONS

Temperature Range	-55 to +105°C
Current Rating	2 A DC
Voltage Rating	250 V AC
Contact Resistance	35 mΩ max. (6 V DC, 0.1A)
Insulation Resistance	1,000 MΩ min. (500 V DC)
Dielectric Withstand Voltage	500 V AC for 1minute
Insertion Force 2 kg max.	(10-pin), 1 kg max. (10-pin S type)
Withdrawal Force	250 g min. (10 pin) 50 g min. (10-pin S type)
Applicable PC Board •	Card edge: 1.6 mm (0.063 in.)

#### MATERIAL

Contact	Copper Alloy
Insulator	Polyester UL94V-0
Contact Plating	Gold over palladium over nickel (PAGOS)



## CONNECTOR APPLICATIONS

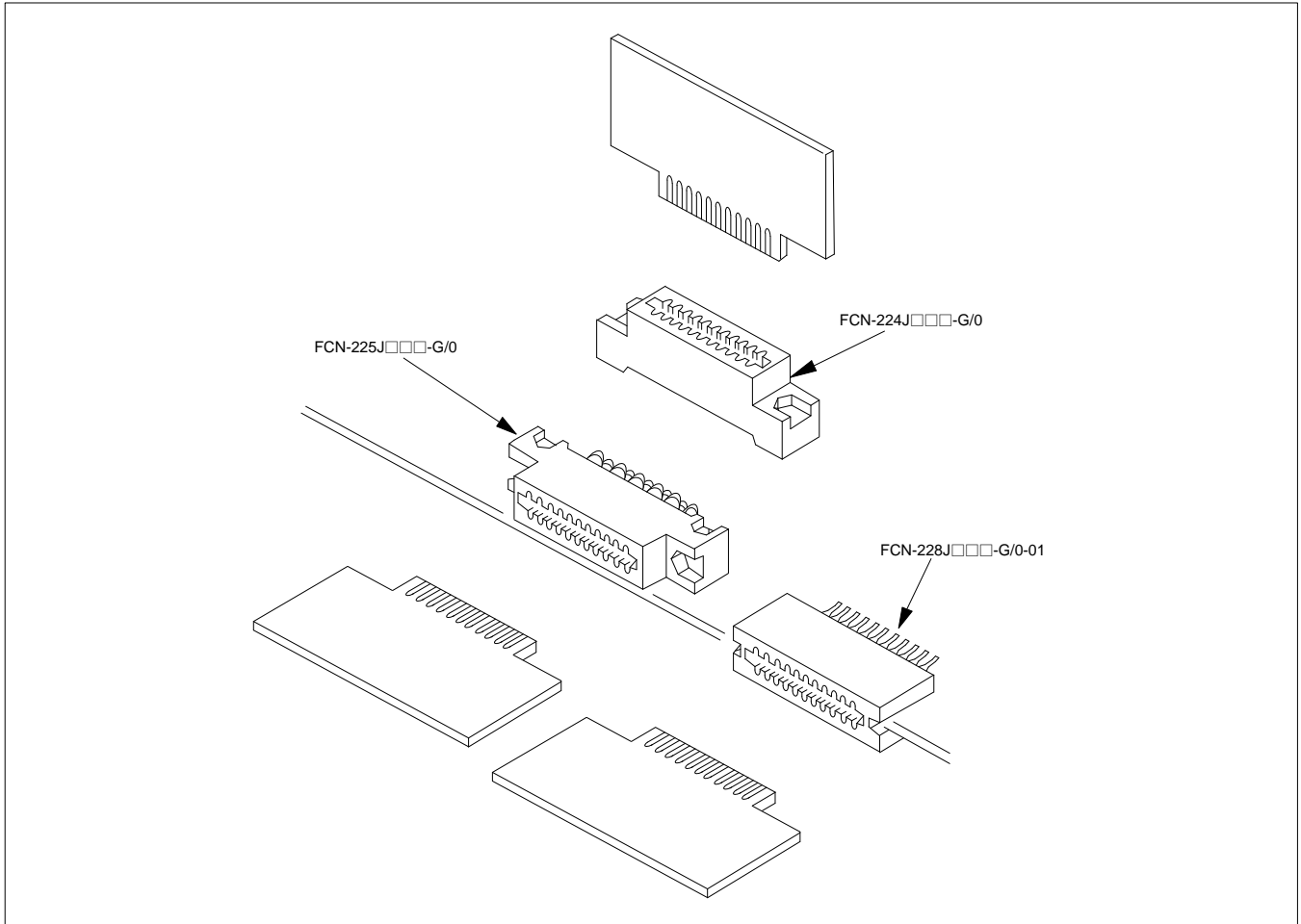

2

FCN-224J\*\*\*-G/0 STRAIGHT TYPE, CARD EDGE

DIMENSIONS

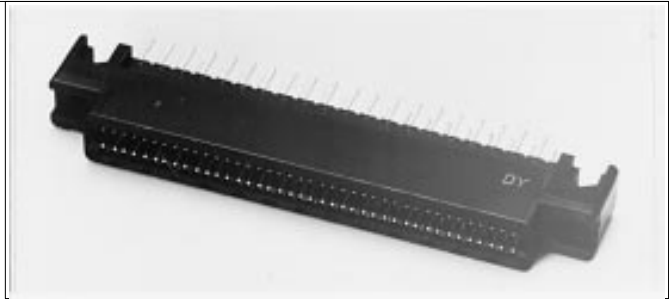
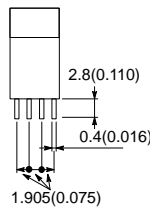
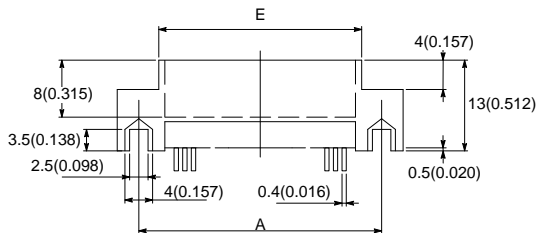
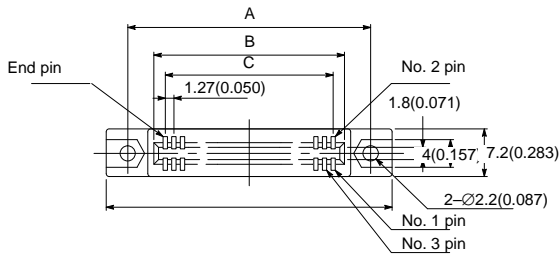

MOUNTING HOLE LAYOUT AND PCB PATTERN

30-,34-,50-,62-contacts

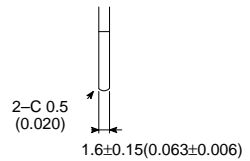
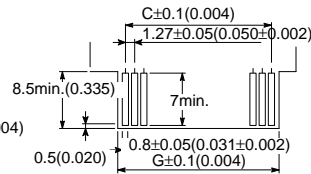
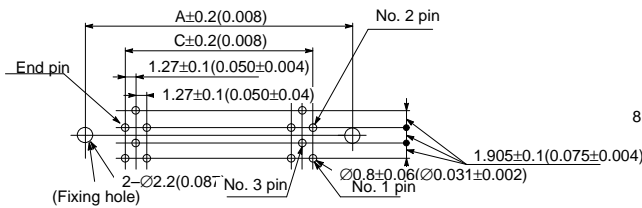

40-,60-,80-,100-,120-contacts

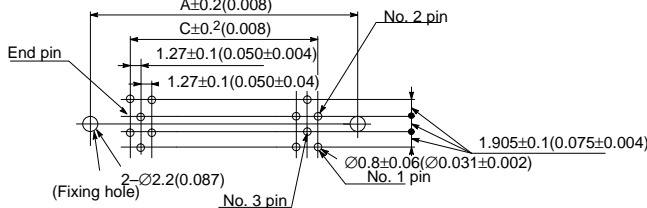

Unit: mm (in.)

PART NUMBERS

No. of Contact	Part Number	Dimensions						
		A	B	C	D	E	F	G
30	FCN-224J030-G/0	28.05 (1.104)	20.32 (0.800)	17.78 (0.700)	34.55 (1.360)	22.25 (0.876)	19.65 (0.774)	20.12 (0.792)
34	FCN-224J034-G/0	30.59 (1.204)	22.86 (0.900)	20.32 (0.800)	37.09 (1.460)	24.79 (0.976)	22.19 (0.874)	22.66 (0.892)
40	FCN-224J040-G/0	34.40 (1.354)	26.67 (1.050)	24.13 (0.950)	40.90 (1.610)	28.60 (1.126)	26.00 (1.024)	26.47 (1.042)
50	FCN-224J050-G/0	40.75 (1.604)	33.02 (1.300)	30.48 (1.200)	47.25 (1.860)	34.95 (1.376)	32.35 (1.274)	32.82 (1.292)
60	FCN-224J060-G/0	47.10 (1.854)	39.37 (1.550)	36.83 (1.450)	53.60 (2.110)	41.30 (1.626)	38.70 (1.524)	39.17 (1.542)
62	FCN-224J062-G/0	48.37 (1.904)	40.64 (1.600)	38.10 (1.501)	54.87 (2.160)	42.57 (1.676)	39.97 (1.574)	40.44 (1.592)
80	FCN-224J080-G/0	59.80 (2.354)	52.07 (2.050)	49.53 (1.950)	66.30 (2.610)	54.00 (2.126)	51.40 (2.024)	51.87 (2.042)
100	FCN-224J100-G/0	72.50 (2.854)	64.77 (2.550)	62.23 (2.450)	79.00 (3.110)	66.70 (2.626)	64.10 (2.524)	64.57 (2.542)
120	FCN224J120-G/0	85.20 (3.354)	77.47 (3.050)	74.93 (2.950)	91.70 (3.610)	79.40 (3.126)	76.80 (3.024)	77.27 (3.042)

FCN-225J\*\*\*-G/0 RIGHT-ANGLE TYPE, CARD EDGE

DIMENSIONS

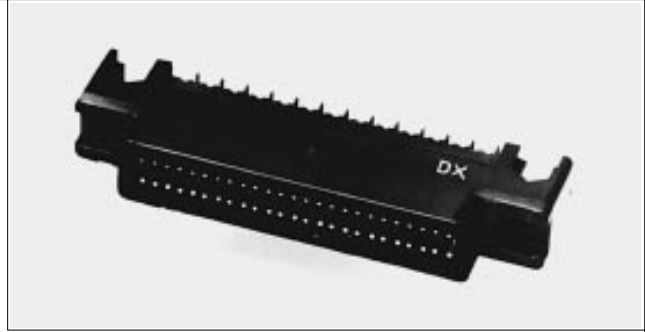
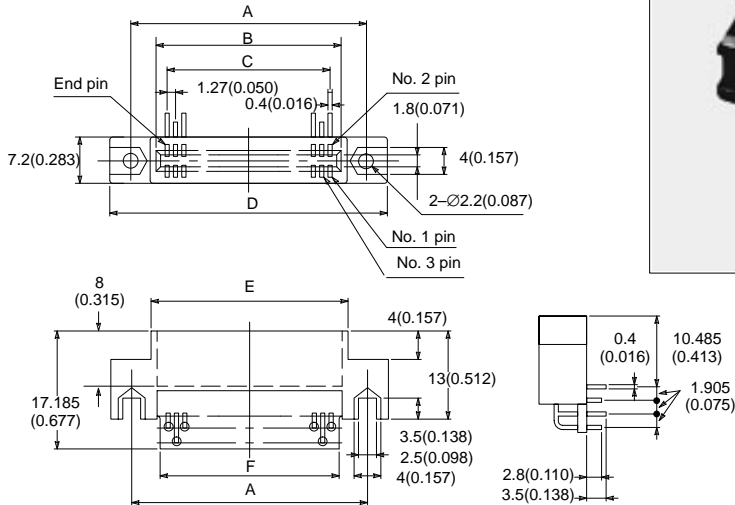

2

MOUNTING HOLE LAYOUT AND PCB PATTERN

30-,34-,50-,62-contacts

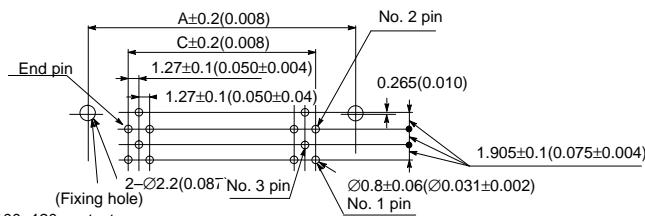

40-,60-,80-,100-,120-contacts

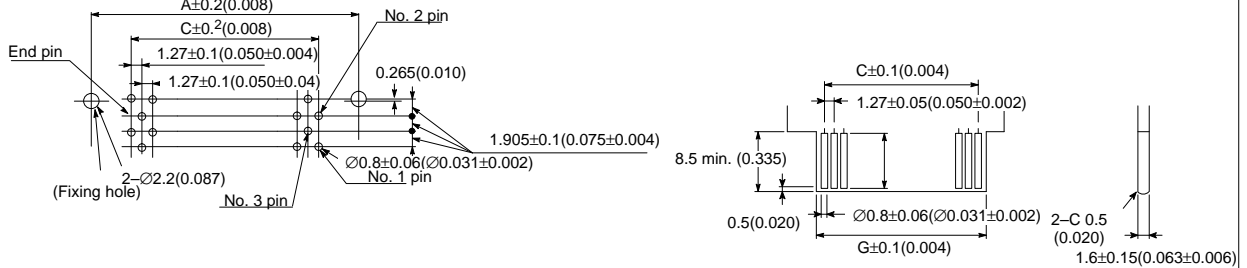

PART NUMBERS

No. of Contacts	Part Number	Dimensions						
		A	B	C	D	E	F	G
30	FCN-225J030-G/0	28.05 (1.104)	20.32 (0.800)	17.78 (0.700)	34.55 (1.360)	22.25 (0.876)	19.65 (0.774)	20.12 (0.792)
34	FCN-225J034-G/0	30.59 (1.204)	22.86 (0.900)	20.32 (0.800)	37.09 (1.460)	24.79 (0.976)	22.19 (0.874)	22.66 (0.892)
40	FCN-225J040-G/0	34.40 (1.354)	26.67 (1.050)	24.13 (0.950)	40.90 (1.610)	28.60 (1.126)	26.00 (1.024)	26.47 (1.042)
50	FCN-225J050-G/0	40.75 (1.604)	33.02 (1.300)	30.48 (1.200)	47.25 (1.860)	34.95 (1.376)	32.35 (1.274)	32.82 (1.292)
60	FCN-225J060-G/0	47.10 (1.854)	39.37 (1.550)	36.83 (1.450)	53.60 (2.110)	41.30 (1.626)	38.70 (1.524)	39.17 (1.542)
62	FCN-225J062-G/0	48.37 (1.904)	40.64 (1.600)	38.10 (1.501)	54.87 (2.160)	42.57 (1.676)	39.97 (1.574)	40.44 (1.592)
80	FCN-225J080-G/0	59.80 (2.354)	52.07 (2.050)	49.53 (1.950)	66.30 (2.610)	54.00 (2.126)	51.40 (2.024)	51.87 (2.042)
100	FCN-225J100-G/0	72.50 (2.854)	64.77 (2.550)	62.23 (2.450)	79.00 (3.110)	66.70 (2.626)	64.10 (2.524)	64.57 (2.542)
120	FCN225J120-G/0	85.20 (3.354)	77.47 (3.050)	74.93 (2.950)	91.70 (3.610)	79.40 (3.126)	76.80 (3.024)	77.27 (3.042)

FCN-224J\*\*\*-G/A, CARD EDGE

DIMENSIONS

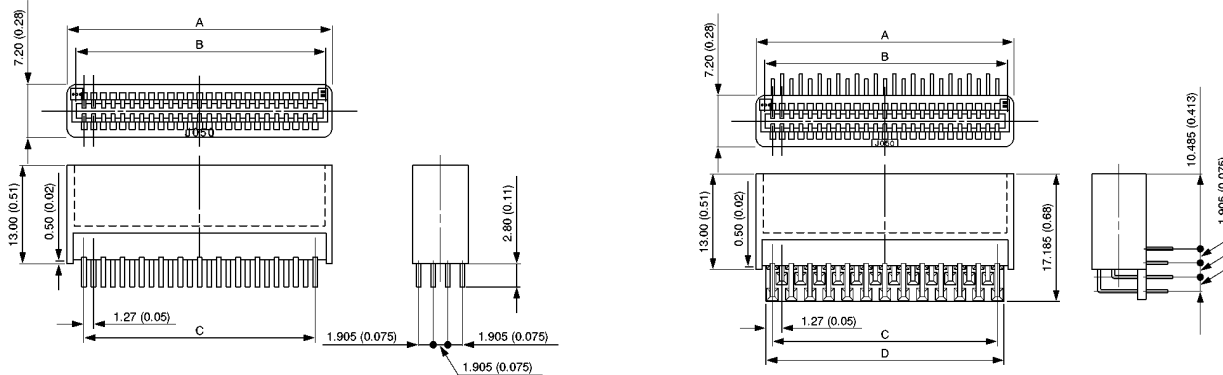

MOUNTING HOLE LAYOUT

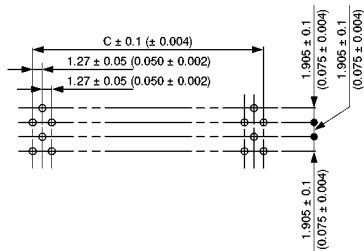

Unit: mm (in.)

PART NUMBERS

No. of Contact	Part Number For Vertical Mount	Part Number For Right Angle	Dimensions			
			A	B	C	D
30	FCN-224J030-G/A	FCN-225J030-G/A	22.25 (0.88)	20.32 (0.80)	17.78 (0.70)	19.65
34	FCN-224J034-G/A	FCN-225J034-G/A	24.79 (0.98)	22.86 (0.90)	20.32 (0.80)	22.19
40	FCN-224J040-G/A	FCN-225J040-G/A	28.60 (1.13)	26.67 (1.05)	24.13 (0.95)	26.00
50	FCN-224J050-G/A	FCN-225J050-G/A	34.95 (1.38)	33.02 (1.30)	30.48 (1.20)	32.35
60	FCN-224J060-G/A	FCN-225J060-G/A	41.30 (1.63)	39.37 (1.55)	36.83 (1.45)	38.70
62	FCN-224J062-G/A	FCN-225J062-G/A	42.57 (1.68)	40.64 (1.60)	38.10 (1.50)	39.97
80	FCN-224J080-G/A	FCN-225J080-G/A	54.00 (2.13)	52.07 (2.05)	49.53 (1.95)	51.40
100	FCN-224J100-G/A	FCN-225J100-G/A	66.70 (2.63)	64.77 (2.55)	62.23 (2.45)	64.10
120	FCN224J120-G/A	FCN225J120-G/A	79.40 (3.13)	77.47 (3.05)	74.93 (2.95)	76.80

